

THE PROPERTY OF THE DRAWING IS ESTABLISHED BY LAW. IT IS FORBIDDEN TO PRODUCE OR SHOW IT TO THIRD PART. WITHOUT A WRITTEN AGREEMENT.

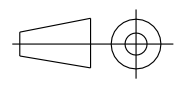
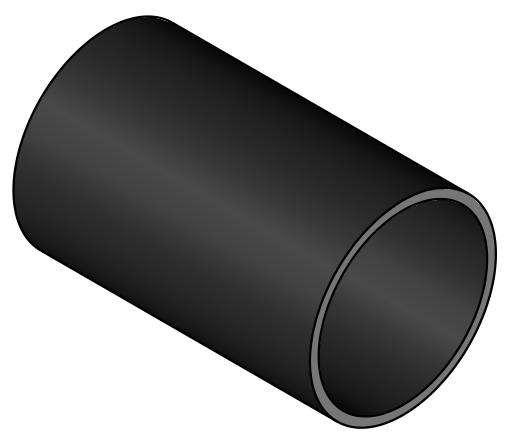
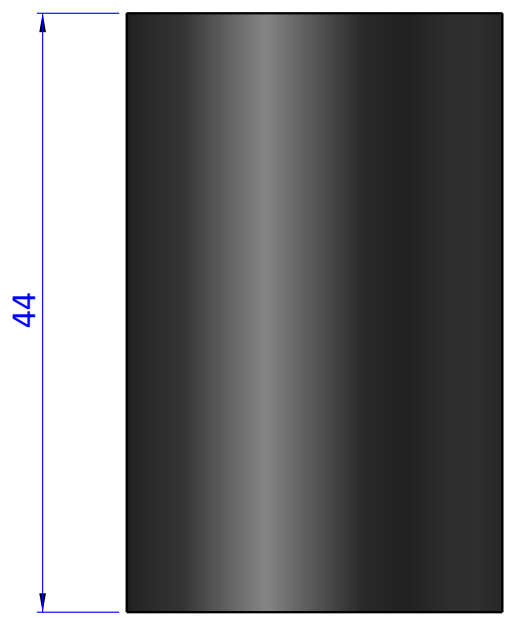
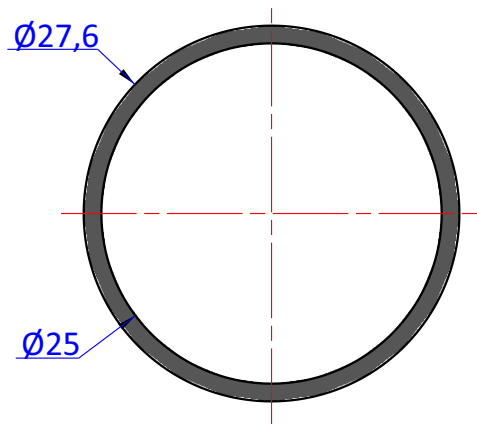

DESIGNED FROM		REVIEW
FPS Automation		A
DATE	WEIGHT	
06/10/2020	0,013kg	
CODE		
CA.09.15.004		

Format A4
UNI 936-76

GENERAL TOLERANCE
UNI - ISO 2768
CLASSE f

DESCRIPTION
CA.09.15.004